

### BENODIGHEDEN

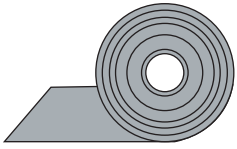

Dakleer / EPDM

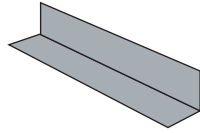

Aluminium profiel

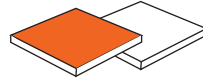

Rubberen tegeldragers

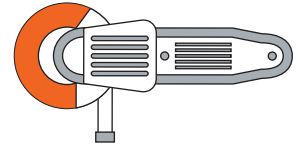

Slijptol



Waterpas

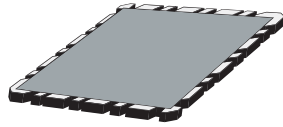

X1 keramische tegels



Kit



Vulplaatjes 2mm/3mm

### STAPPENPLAN



1

Vervoer de X1 Keramische tegels naar het dak / balkon.

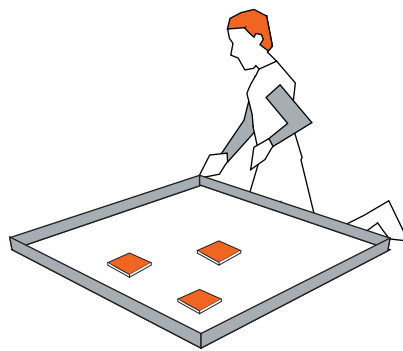

2

Bij beton dakleer/EPDM tegeldragers van 15x15 of 20x20cm uitleggen.

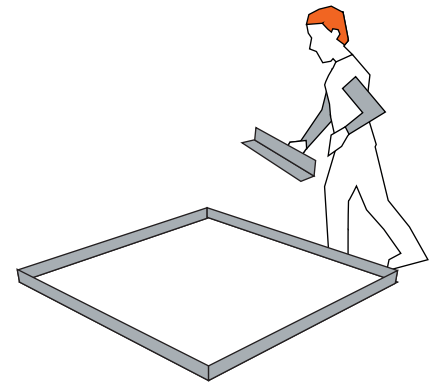

3

Plaats aluminium profielen indien nodig.

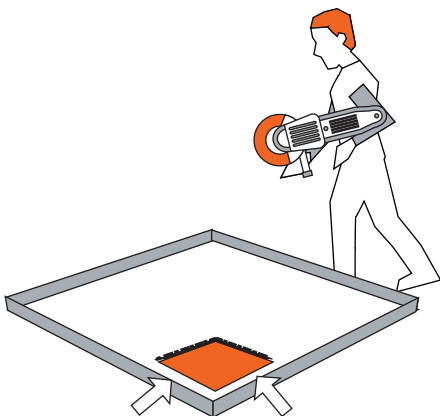

4

Slijp de vertanding af van de kant die in de hoek komt te liggen.

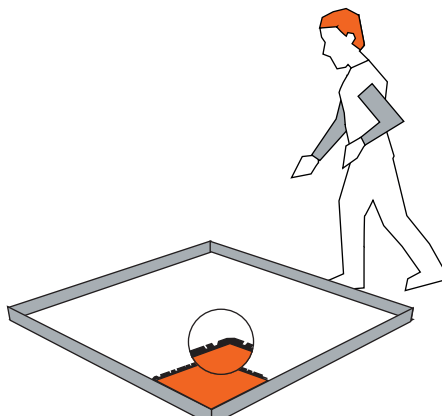

5

Zorg voor de goede legrichting (de vertanding wijst in de legrichting).

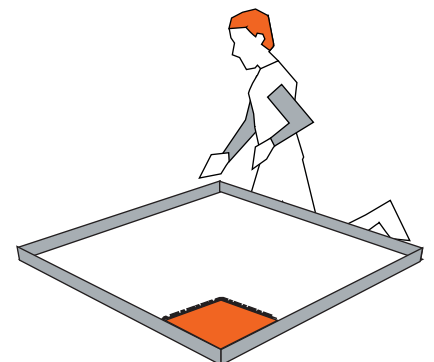

6

Begin in de tegenovergestelde hoek van waar je wilt eindigen.

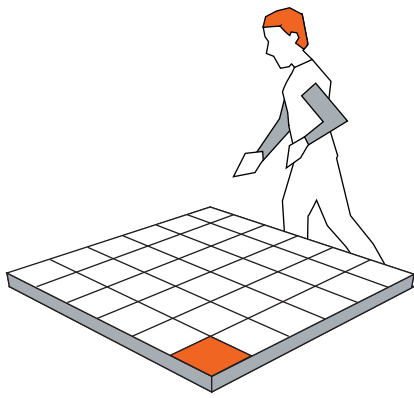

**7** Schuif alle X1 terrastegels goed in elkaar.

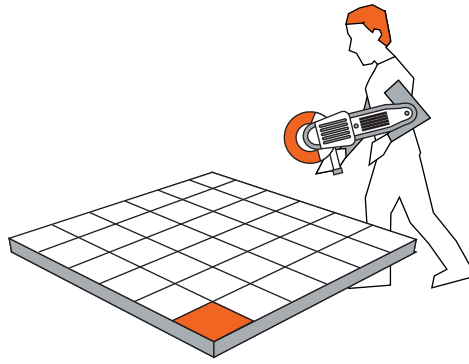

**8** Slijp waar nodig de vertanding af en/of de tegels op maat.

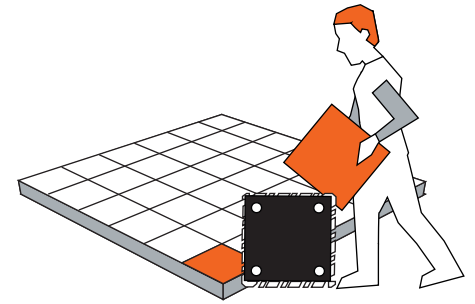

**9** Haal de laatste tegel los van de bufferingsmat.

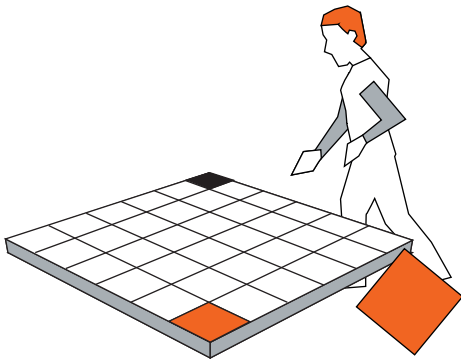

**10** Leg de losse bufferingsmat in de hoek.

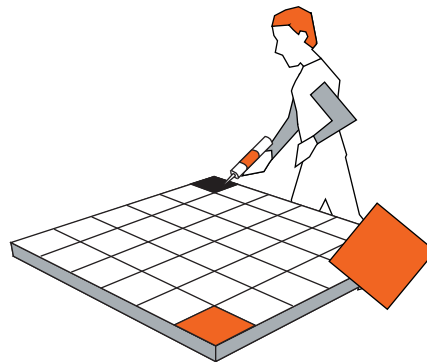

**11** Plaats dotten kit op de kiteitanden op de bufferingsmat.

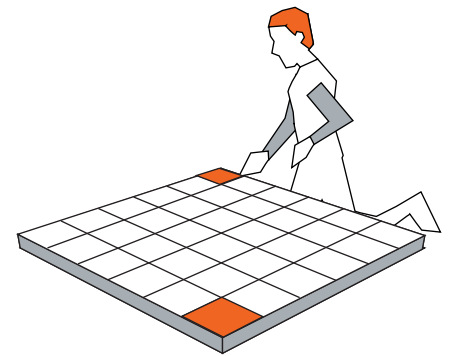

**12** Plaats de laatste tegel op de bufferingsmat en laat hechten.

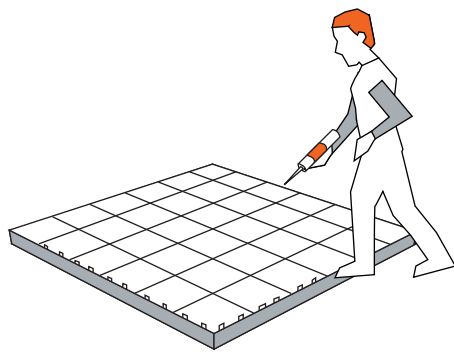

**13** Span het terras rondom goed op met vulplaatjes. Kit het terras rondom eventueel af.

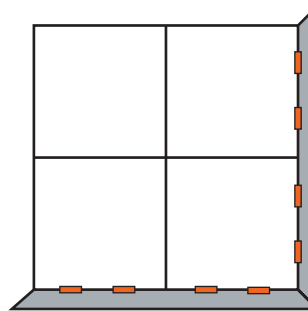

**14** Detailtekening vulplaatjes.