

BENODIGHEDEN

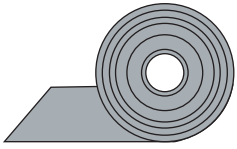

Dakleer / EPDM

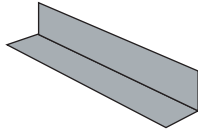

Aluminium profiel

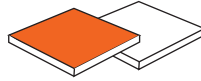

Rubberen tegeldragers

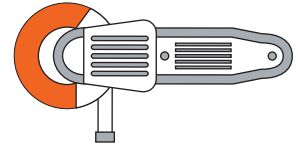

Slijptol



Waterpas

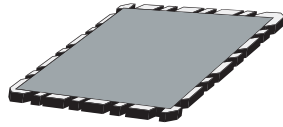

X1 keramische tegels



Kit



Vulplaatjes 2mm/3mm

STAPPENPLAN



1

Vervoer de X1 Keramische tegels naar het dak / balkon.

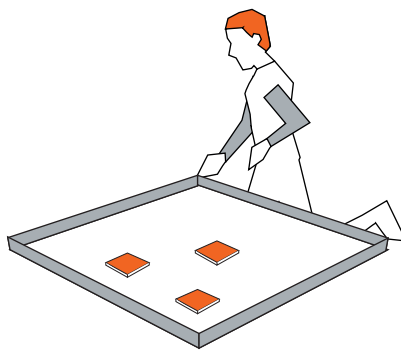

2

Bij beton dakleer/EPDM tegeldragers van 15x15 of 20x20cm uitleggen.

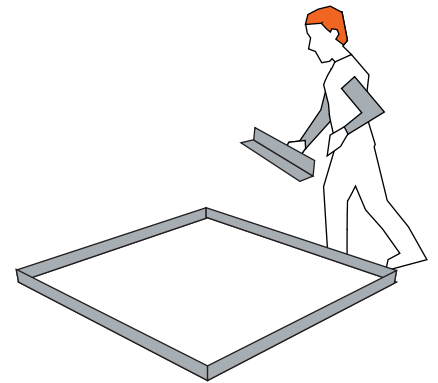

3

Plaats aluminium profielen indien nodig.

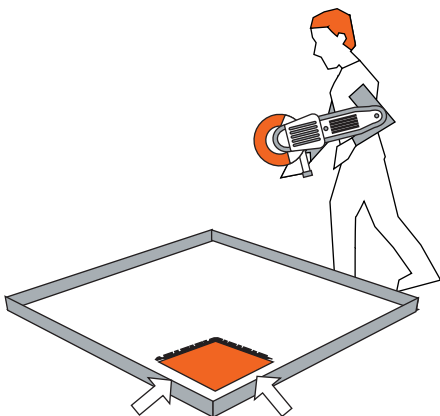

4

Slijp de vertanding af van de kant die in de hoek komt te liggen.

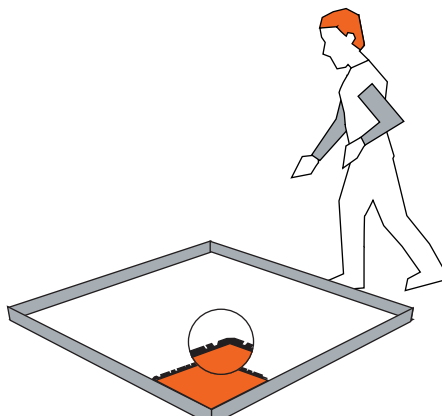

5

Zorg voor de goede legrichting (de vertanding wijst in de legrichting).

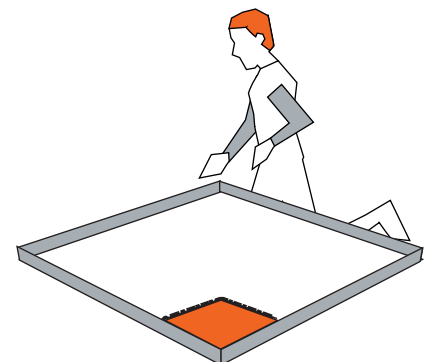

6

Begin in de tegenovergestelde hoek van waar je wilt eindigen.

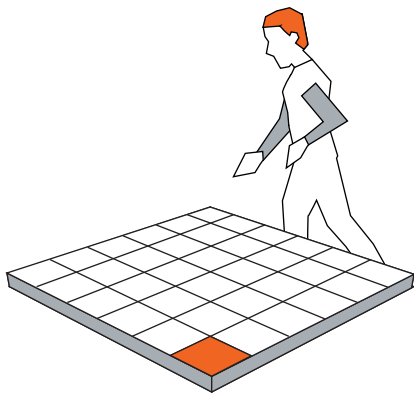

7

Schuif alle X1 terrastegels goed in elkaar.

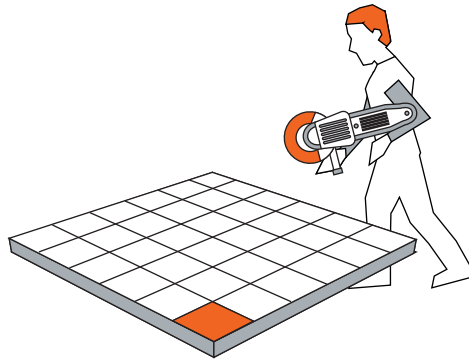

8

Slijp waar nodig de vertanding af en/of de tegels op maat.

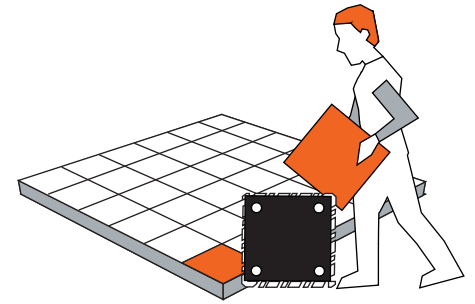

9

Haal de laatste tegel los van de bufferingsmat.

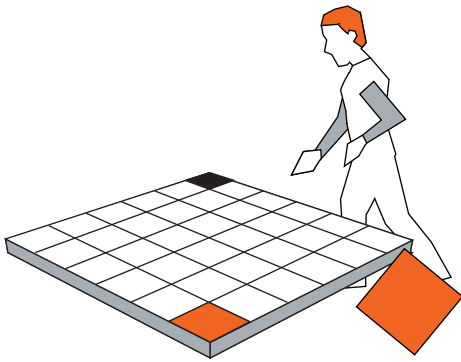

10

Leg de losse bufferingsmat in de hoek.

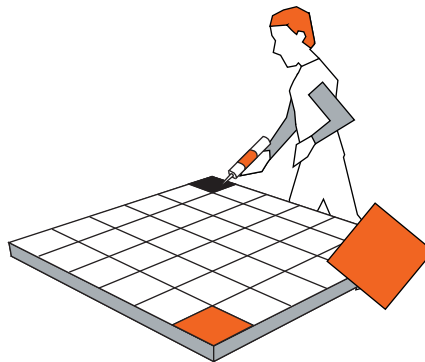

11

Plaats dotten kit op de kiteitanden op de bufferingsmat.

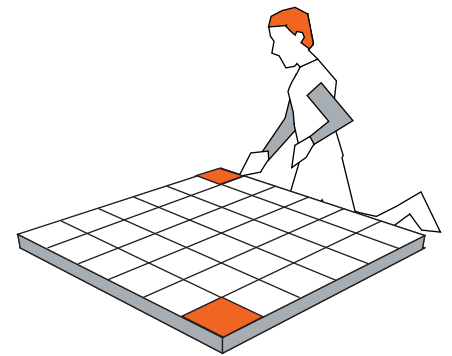

12

Plaats de laatste tegel op de bufferingsmat en laat hechten.

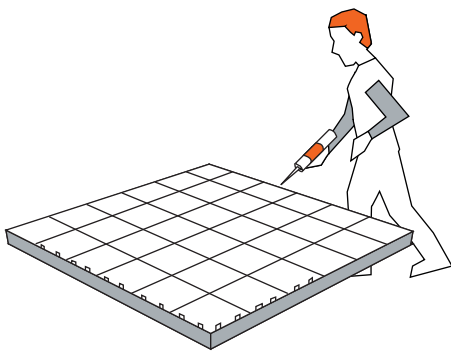

13

Span het terras rondom op met vulplaatjes. Herhaal dit wanneer nodig na enige periode. Kit het terras daarna rondom af.

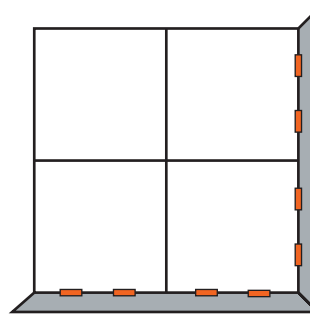

14

Detailtekening vulplaatjes.